

STAGE CHAFING-DISH

Mobile buffet-table with openings to install built-in chafing-dish units.



The mobile buffet table STAGE_CHAFING-DISH consists of a metal frame on castors and a table top made of the material „compact panel / high pressure laminate“.

The idea is to integrate the CHAFING-DISH, often used in the hotel industry, into the table top and thus give the proven warming concept a more appealing appearance.

The table top is provided with openings, into each of which a 1/1 GN built-in Chafing dish can be inserted flush with the surface. When not in use, the openings can be completely closed with insert plates (included in delivery). The table top can thus be used as a practical storage area.



STAGE_50_XS_CHAFING_DISH_1



STAGE_80_XS_CHAFING_DISH_1



STAGE_80_XS_CHAFING_DISH_2



STAGE_50_M_CHAFING_DISH_2



STAGE_80_M_CHAFING_DISH_3



STAGE_80_M_CHAFING_DISH_4

Buffet table prepared to insert CHAFING-DISH unit



color example 100|402

Item No.: 81078

[LxWxH]: 1800 x 800 x 855 mm
total weight: 53,8 kg

Base

material: steel, powder-coated
profile: 40 x 40 mm
weight: 17,3 kg with height compensation
4 x castor, diameter = 65 mm
height adjustable: 935, 1015, 1095 mm

Table-top

[LxWxH]: 1790 x 790 x 140 mm
material: compact laminate, 10 mm
weight: 36,5 kg
cutouts: 4
cutout size: 516 x 312 mm

Additional items

2 x plugbar (available for every region)
2 x 11765_magnetic_cable_duct_770mm

Warranty

1 year

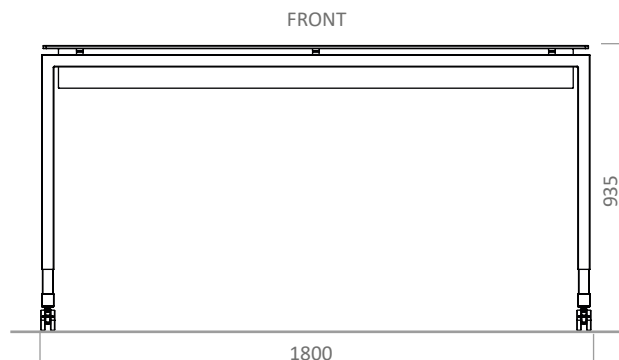
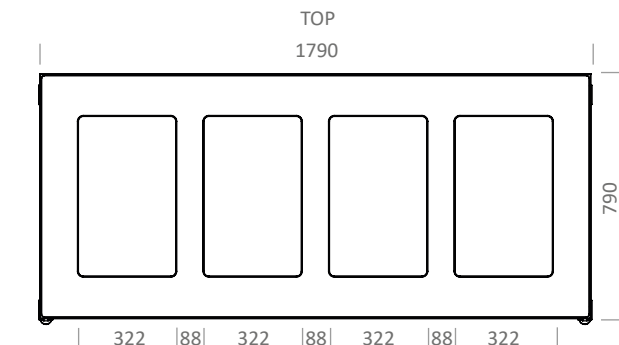

connection between table-top and base

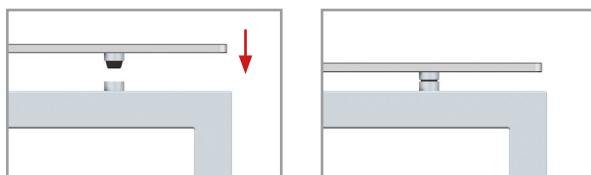

Buffet table prepared to insert CHAFING-DISH unit



color example 100|402

Item No.: 81079

[LxWxH]: 1800 x 800 x 855 mm
total weight: 53,8 kg

Base

material: steel, powder-coated
profile: 40 x 40 mm
weight: 17,3 kg with height compensation
4 x castor, diameter = 65 mm
height adjustable: 935, 1015, 1095 mm

Table-top

[LxWxH]: 1790 x 790 x 140 mm
material: compact laminate, 10 mm
weight: 36,5 kg
cutouts: 3
cutout size: 516 x 312 mm

Additional items

2 x plugbar (available for every region)
2 x 11765_magnetic_cable_duct_770mm

Warranty

1 year

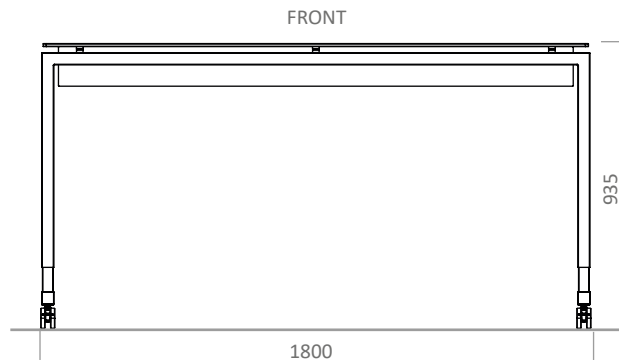
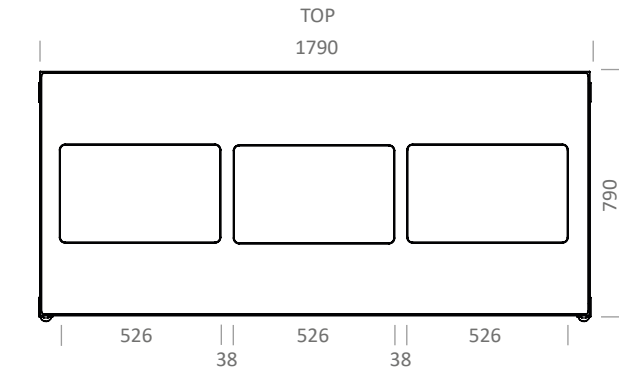

connection between table-top and base

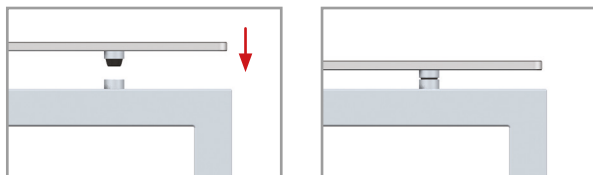

Buffet table prepared to insert CHAFING-DISH unit



color example 100|402

Item No.: 81080

[LxWxH]: 800 x 800 x 775 mm
total weight: 29,2 kg

Base

material: steel, powder-coated
profile: 40 x 40 mm
weight: 12,8 kg with height compensation
4 x castor, diameter = 65 mm
height adjustable: 855, 935, 1015 mm

Table-top

[LxWxH]: 790 x 790 x 140 mm
material: compact laminate, 10 mm
weight: 16,4 kg
cutouts: 2
cutout size: 516 x 312 mm

Additional items

2 x plugbar (available for every region)
2 x 11765_magnetic_cable_duct_770mm

Warranty

1 year

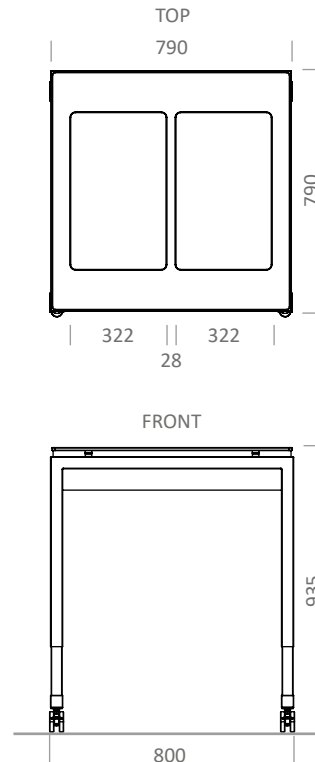

connection between table-top and base

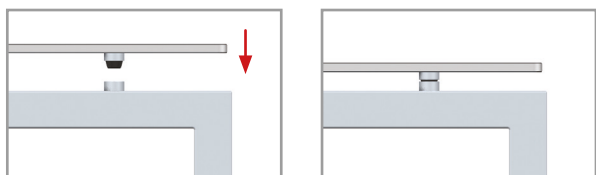

Buffet table prepared to insert CHAFING-DISH unit



color example 100|402

Item No.: 81081

[LxWxH]: 800 x 800 x 775 mm
total weight: 29,2 kg

Base

material: steel, powder-coated
profile: 40 x 40 mm
weight: 12,8 kg with height compensation
4 x castor, diameter = 65 mm
height adjustable: 855, 935, 1015 mm

Table-top

[LxWxH]: 790 x 790 x 140 mm
material: compact laminate, 10 mm
weight: 16,4 kg
cutouts: 1
cutout size: 516 x 312 mm

Additional items

2 x plugbar (available for every region)
2 x 11765_magnetic_cable_duct_770mm

Warranty

1 year

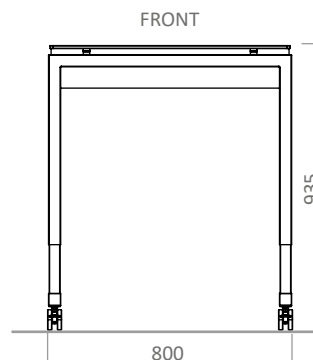
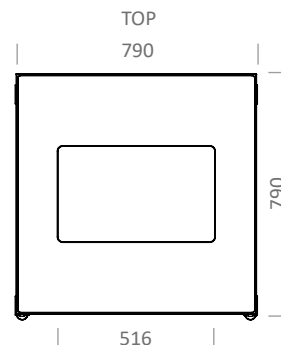

connection between table-top and base

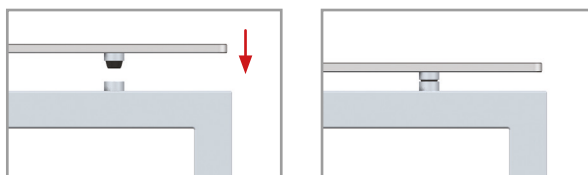

Buffet table prepared to insert CHAFING-DISH unit



color example 100|402

Item No.: 51042

[LxWxH]: 1800 x 500 x 855 mm
total weight: 41,1 kg

Base

material: steel, powder-coated
profile: 40 x 40 mm
weight: 15,6 kg with height compensation
4 x castor, diameter = 65 mm
height adjustable: 935, 1015, 1095 mm

Table-top

[LxWxH]: 1790 x 490 x 140 mm
material: compact laminate, 10 mm
weight: 25,5 kg
cutouts: 2
cutout size: 516 x 312 mm

Additional items

1 x plugbar (available for every region)
2 x 11765_magnetic_cable_duct_770mm

Warranty

1 year

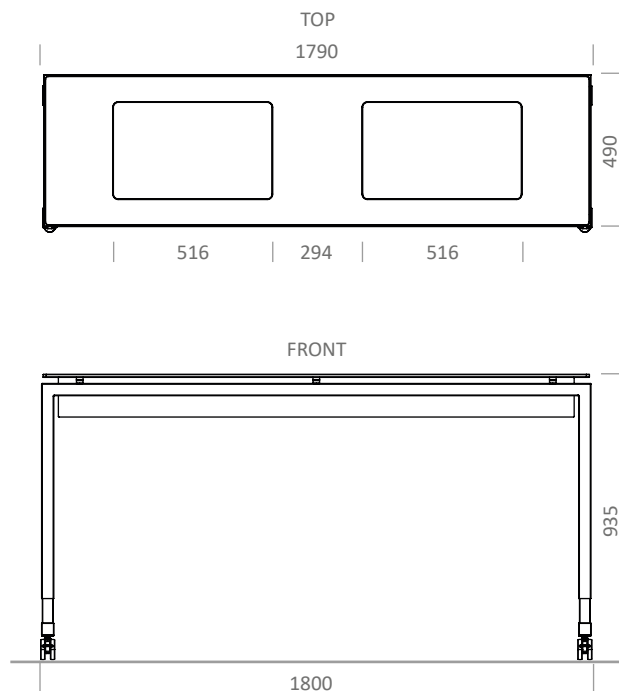

connection between table-top and base

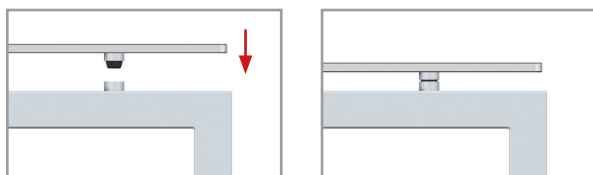

Buffet table prepared to insert CHAFING-DISH unit



color example 100|402

Item No.: 51043

[LxWxH]: 800 x 500 x 775 mm
total weight: 27 kg

Base

material: steel, powder-coated
profile: 40 x 40 mm
weight: 11,6 kg with height compensation
4 x castor, diameter = 65 mm
height adjustable: 855, 935, 1015 mm

Table-top

[LxWxH]: 1790 x 490 x 140 mm
material: compact laminate, 10 mm
weight: 15,4 kg
cutouts: 1
cutout size: 516 x 312 mm

Additional items

1 x plugbar (available for every region)
2 x 11765_magnetic_cable_duct_770mm

Warranty

1 year

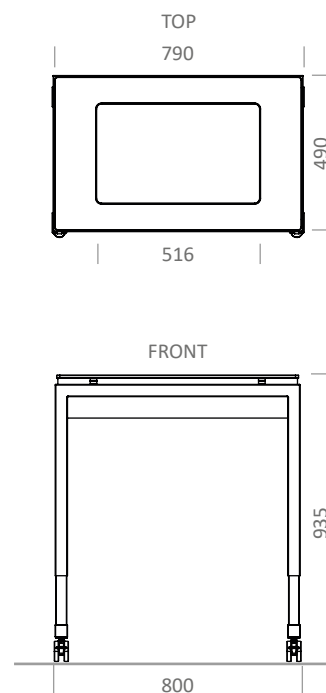

connection between table-top and base

