

AIR-VENT solution for indoor cooking

Eliminate kitchen odors, bacterias, viruses, germs, spurs

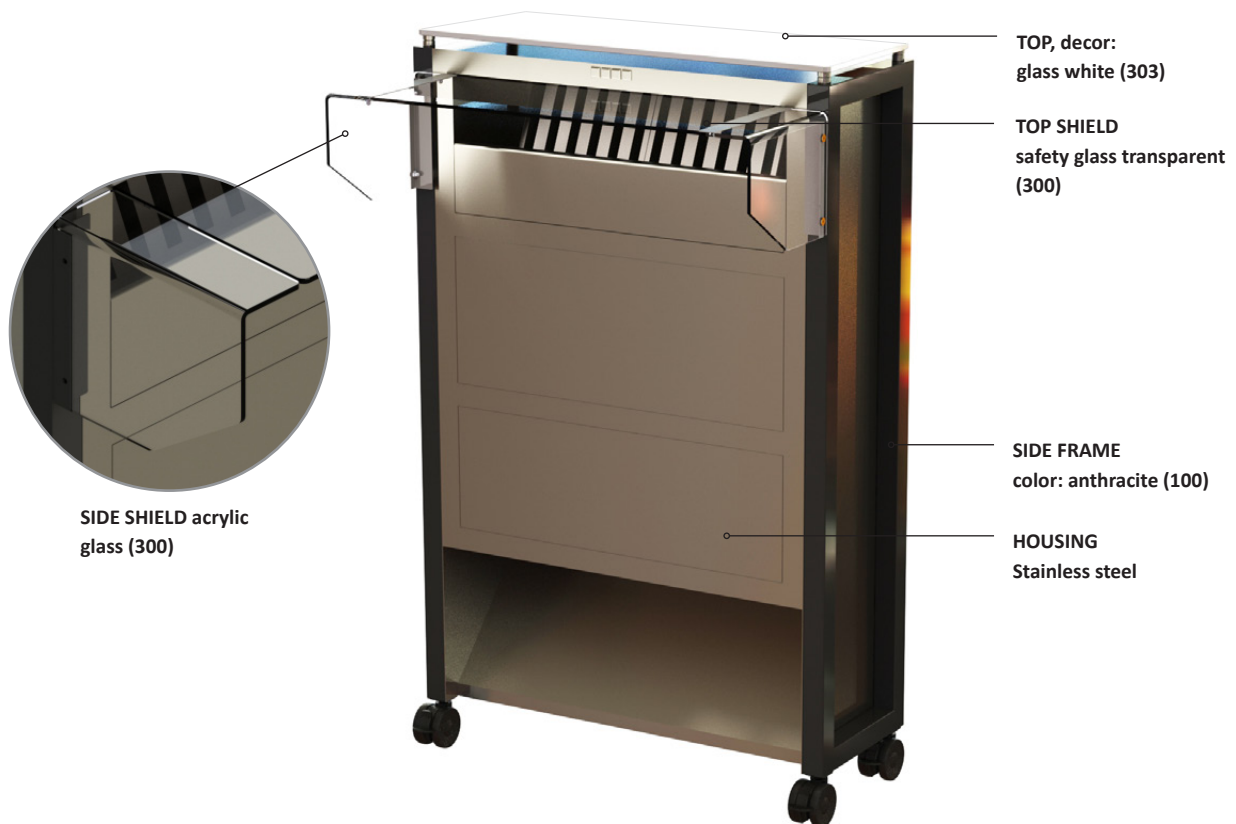

color example

Item-No.: 66038

measures: [LxWxH]: 300 x 800 x 1270 mm
total weight: 60 kg

Base

steel, powder-coated, profile 40 x 40 mm
4 x castor, available diameter
50mm (item.no.: 66038)
65mm (item.no.: 66039)
75mm (item.no.: 66040)
(all castors with brake)

Top plate

dimensions: 290 x 790 x 10 mm
material/table-top: safety glass or compact panel,
10 mm
total weight: glass 12 or compact panel 7,5 kg

Top Shield

dimensions: 450 x 635 mm
material/table-top: safety glass, 6 mm
total weight: 4,5 kg

Side Shield

dimensions: 200 x 250 x 70 mm
material/table-top: acrylic glass, 6 mm
total weight: 0,5 kg

Housing

Stainless steel 1.4301 whole construction
Stainless steel 1.4416 on guest side and side left /
right (for covering with venta magnetic blinds)

Classification: DIN EN 1008-3

approved for the food industry

Technical data:

Filter: 2x professional combi filter type A (grease eddy current / mesh), plasma filter, carbon filter

Odor removal: cooking + kitchen smells, nicotine, aerosols

Filter properties: bacteria, virus, germs, spurs

Condensate tray: (2x) 250x35mm inox 1.4301

Connected value: 1/N/PE AC 230V 50Hz, 130W

Operational loudness: max 54dBA

Power Level: 1/470m³h, 2/570m³h; 3/670m³h, **4/820m³h**, with trailing automatic 10/60 min.

Cable: L= 1,5m, schuko type F on cold device socket type C19

LED light: 7,5W with 3800K neutral white

Warranty: 1 year

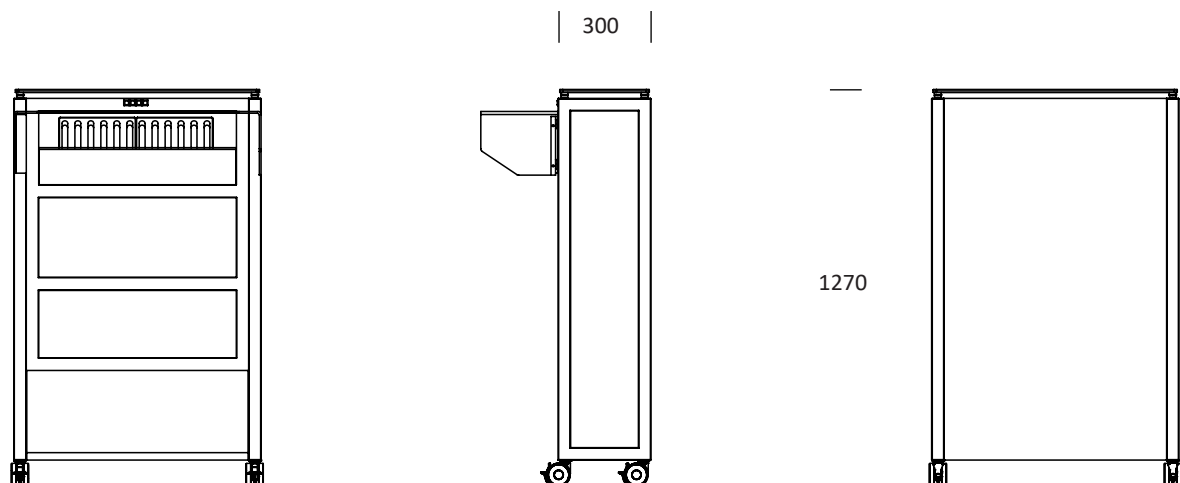
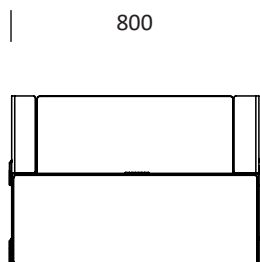
measures overview

suitable equipment

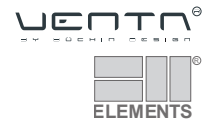

Item-nr.: 38089

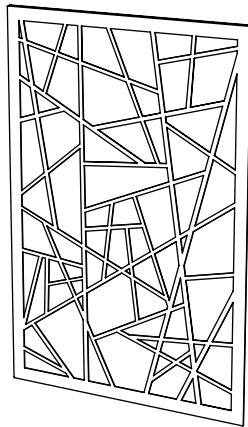

FRONTBLIND_BAMBOO_COV_AIRMOBIL_80

Item.-nr.: 38090

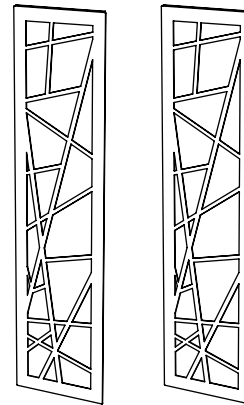

SIDEBLIND_BAMBOO_COV_AIRMOBIL_80

Item-nr.: 38087

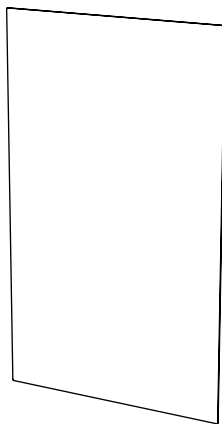

FRONTBLIND_AIRMOBIL_80

Item-nr.: 38088

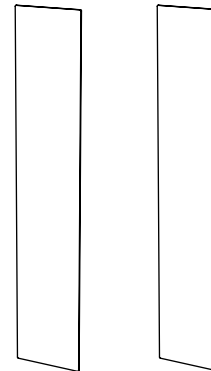

SIDEBLIND_AIRMOBIL_80

Item-nr.: 11160

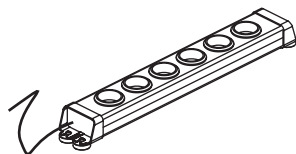

plugbar_CEE_400V_3x16A_3600W

Item-nr.: 11161

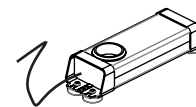

plugbar_UK_230V_1x13A_3200W

suitable equipment



FRONTBLIND and SIDEBLIND
in compact panel or
powdered steel plate with
outcutting designs.
For covering and decoration.
Assembling with magnets.
Customized designs.



Storage cover to
protect against dust,
scatchings and bumps.
With pockets to store steam
glass and side shields.

Item-nr.: 78011



Trolley for transportation on
trucks.
With tray to store top plate,
steam glass and side shields.

Item-nr.: 99148